

VANSHIKA TECHNOLOGY

CATALOGUE OF LASER PRODUCTS



Add- Shop No.09 Dattir Appt. Opp. Nashik Engg. Cluster Company ,
XLO Point MIDC Ambad
NASHIK-422009
Maharashtra

Email- vanshikatechnology2016@gmail.com

Mob No- 8888734139

TABLE OF CONTENT

■ Laser Nozzles	03
■ Laser Welding Nozzles	11
■ Laser Ceramic Rings	15
■ Laser Protective Lens	19
■ Laser Sensors	27
■ Laser Seal Rings	33
■ Laser Induction Line	37
■ Laser QBH Interface	41
■ Laser Lock Nut Ring	43
■ Fiber Protective Cap	45
■ Lens Removal Tools	47
■ Laser Protective Lens Holder	49
■ Filter Element	51

NOZZLES



Single

Double

Chromed

The nozzle diameter is 0.8-5.0, and the double-layer nozzle is chrome or non chrome



H11 Single

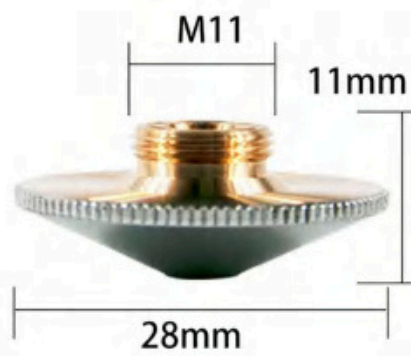

H11 Chromed



D28 Single

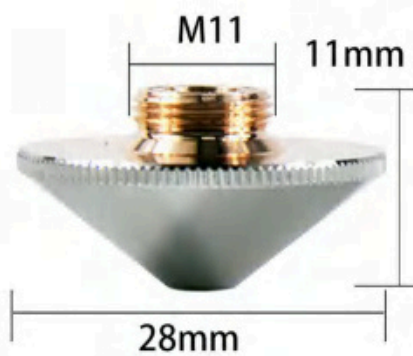

D28 Double Chromed



D32 Single



D32 Double Chromed

NOZZLES



Hongshan D28 Single



Hongshan D28 Double Chromed



High Speed D28 Single



High Speed D28 Double Chromed



High Speed D32 Single

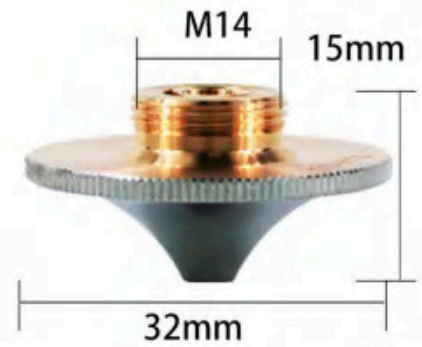

High Speed D32 Double Chromed



Straw Hat H11 Single



Straw Hat H11 Double Chromed



Straw Hat D28 Single

NOZZLES



Straw Hat D28 Double Chromed



Straw Hat D32 Single



Straw Hat D32 Double Chromed



3D M6 Single



3D M8 Single



3D M8 Double Chromed



3D M9 Single



Bullet Single



Bullet Double

NOZZLES



Bullet Single Chromed



Bullet Double Chromed

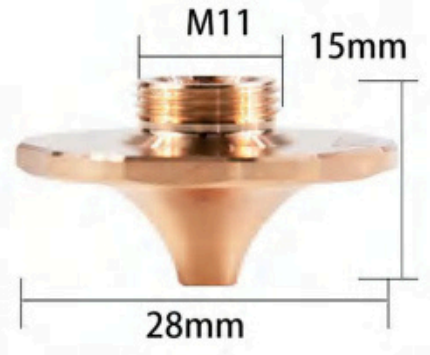

Hans Single Step



Hans Single Chromed Step



Hans Single



Hans Double

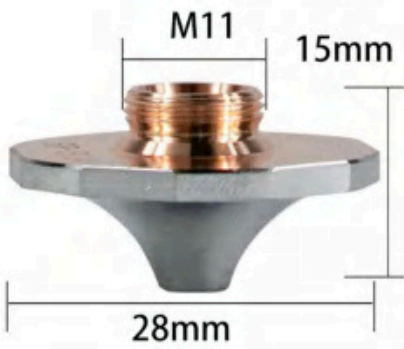

Hans Double Chromed



Hans New Single



Hans Turbo Single

NOZZLES

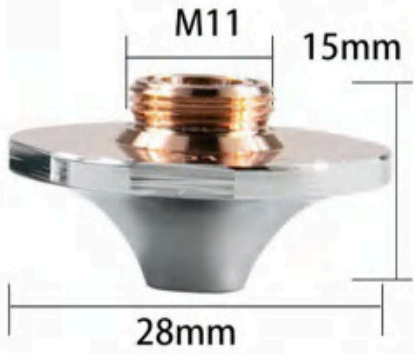

Hongshan SP



Hans SP



Chutian Booster



Bodor Single



Bodor Double



New Bodor Single



WSX Single



WSX Double



WSX 3D

NOZZLES



Trumpf EAA Single



Trumpf EAU Double



Trumpf EAK Double



Trumpf Double



Trumpf ECE



Xunlei



Precitec 2.0 Single



Precitec 2.0 Double



Precitec small 3D

NOZZLES



Tongli Single



Tongli Double Chromed



Long Nozzle



DNE Small Single Chromed



DNE Small Double Chromed



DNE 10000-watt Single



DNE 10000-watt Double

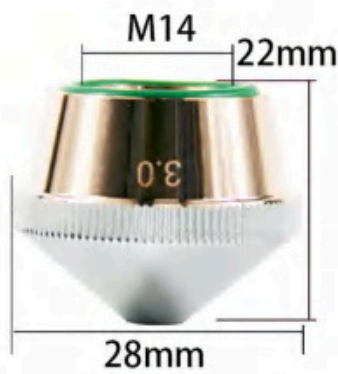

DNE Single



DNE Double

NOZZLES



Bystronic HK Single



Bystronic HK Double



Prima 3D Single



Amada Single



Amada Double



Amada Water Cooling Single



Amada Water Cooling Double



Huagong/Tianhong Single



Precision nozzle

WELDING NOZZLE



Qilin • Short A



Qilin • Short B



Qilin • Short C



Qilin • Short D



Qilin • Short E



Qilin • Cutting Nozzle



Qilin • Wire Guide nozzle



Qilin • Long A



Qilin • Long B

WELDING NOZZLE



Qilin • Long C



Qilin • Long D



Qilin • Long E



IPG • Type O



IPG • Type Y



IPG • Welding Nozzle



IPG • Sharp Type



WSX • Long Type A



WSX • Wire Feeding Nozzle A

WELDING NOZZLE



WSX Short Type B



WSX Wire Feeding Nozzle E



WSX Wire Feeding Nozzle G



WSX Semicircular



WSX • Long and Short Feet



Hanwei Wire Feeding Nozzle E



Hanwei Wire Feeding Nozzle E



Hanwei Cutting Type F



Hanwei Wire Feeding Nozzle G

WELDING NOZZLE



Hanwei • Opening Short Type



Hanwei • Opening Long Type



Hanwei • Old Wire Feeding Nozzle



Hanwei • Oblique Angle 45

CERAMICS

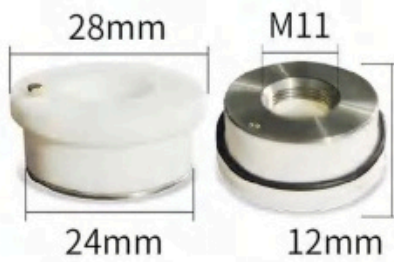

D28



D32



Raytools • D19.5 M8



Raytools • D21.4 M8



Raytools • D21.4 M11

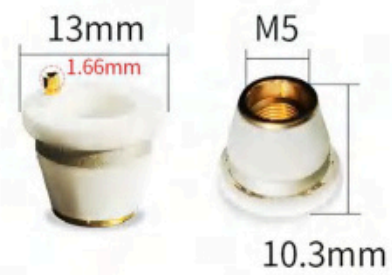

Precitec • D13 M5



Precitec • D17 M6

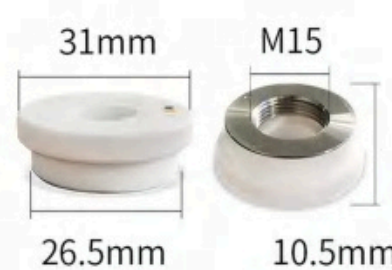

Precitec • KTX



Precitec • KTXB

CERAMICS



Precitec KTB2 CON II



WSX • D15.6



WSX • D19.5



WSX • ND18



WSX • WTC08



WSX • WTC05



WSX • D24



Trumpf • 1906032



Bystronic • 10032838

CERAMICS

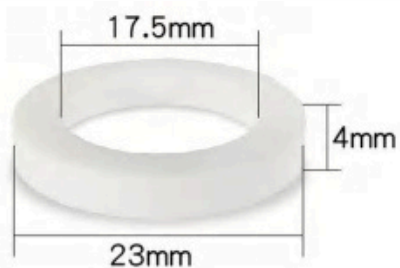

Bystronic • 4-01642

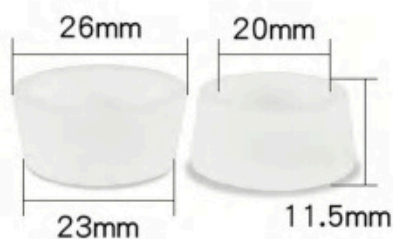

Bystronic • 4-01959

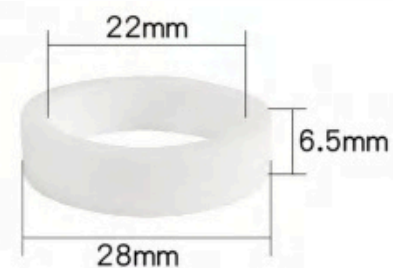

Bystronic • 4-09010



OsPRI D21.4 New



OsPRI 3D M8



OsPRI

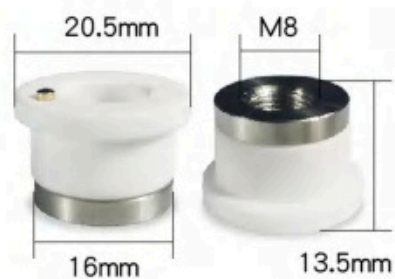

Bodor • 3D M8

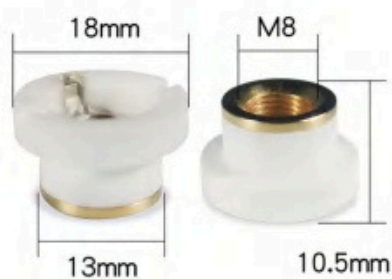

CKY • 3D M8



MAX • M11

CERAMICS



Gangchun • M11



Gangchun • M9



Boci M11



Highyag D35 M11



Highyag D24.5 M11

PROTECTIVE LENS

Installation drawing

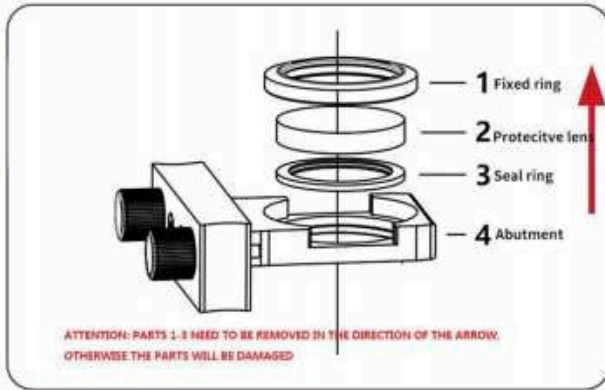

Structural drawing

DIAMOND FILM, ION BOMBARDMENT SEALED COATING

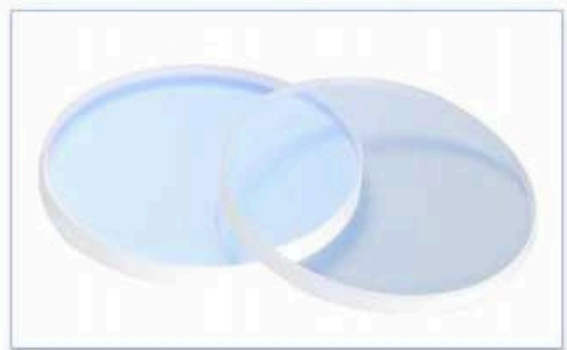
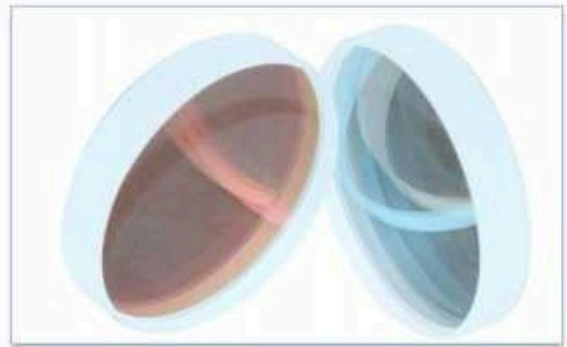
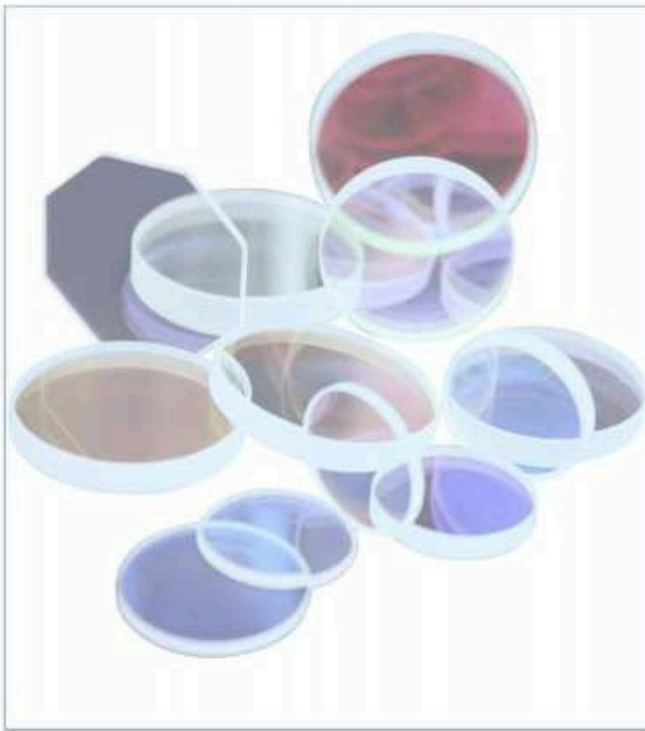
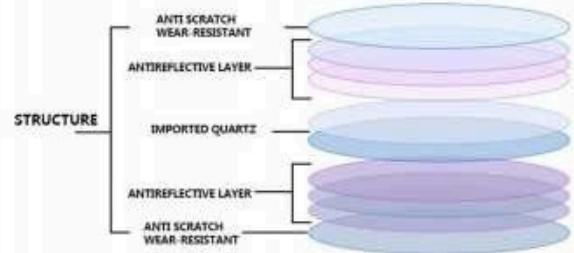

Imported quartz double-layer coating with high transmittance

High temperature and high pressure resistance, excellent optical performance;

Anti scratch and enhanced transparency, with longer service life

PROTECTIVE LENS

10/20 Series		30 Series		40 Series	50 Series	> 60 Series
Diameter*Thickness						
10*1	24.7*2	30*1	35*4	40*1.5	50*1.5	60*3
18*2	24.9*1.5	30*1.5	35*5	40*2	50*2	60.05*14.4
19.05*1.5	25*1	30*2	35.5*5	40*2.5	50*3	62*9.5
20*1.5	25*1.5	30*3	36*2	40*3	50*3.3	96*3
20*2	25*2	30.4	36*3	40*5	50*4	113*3
20*3	25*3	30*5	36*5	40*7	50*5	134*3
20*4	25*4	30*5	37*1.6	40*8	50*8	140*4
21.5*2	25.4*3	32*2	37*3.5	40*9	50.8*1	145*3
21.8*1.8	25.4*4Y	32*3	37*5	42*3	50.8*9.5	
22*1.7	25.4*5	32*4	37*7	42*4	52*2	
22*2	26*4	32*5	38*1.5	42*7	55*1.5	
22.35*3.18	26.5*5	32*6.35	38*2	42*9	55*9	
22.25*4	26.8*2	33.8*3	38*3	45*1.5		
22.35*4.1	27*4	34*2	38*5	45*3		
22.4*4.1	27.9*4.1	34*3	38*6.35	46*2		
24*5	28*2	34*5	38*6.5	48*3		
24.4*2	29.7*4.7	35*1.5	38*10			
			38,1*1.6			
			38,1*2			
			38,1*9.35			

Unit: mm

Product parameters

Name: Laser protective lens

Thickness: 1-9mm

Finish: 40-20

Transmittance: >99.95%

Focusing difference: ± 0.1 mm

Coating film: AR/AR@1030-1090nm(T>99.9%@960-1080nm)

Material: quartz

Angle: $\pm 0.3^\circ$

Public errand: ± 0.08 mm

Diameter: 10-90mm

Structure of the focusing lens

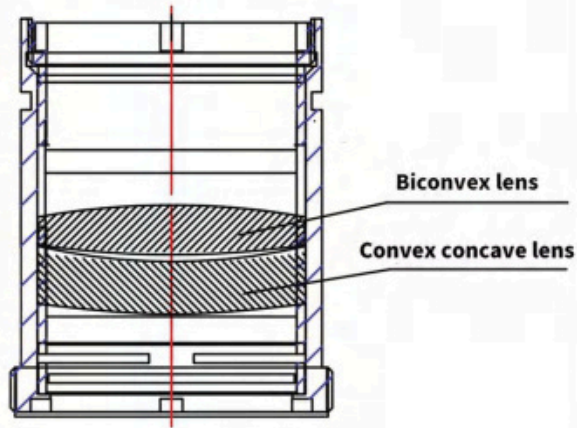

Structure of the collimating lens

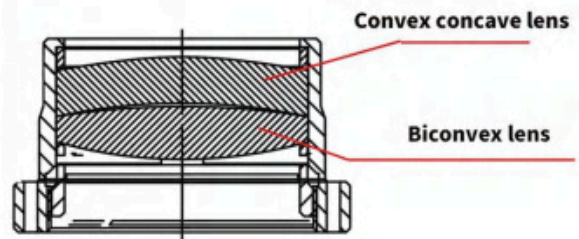

**High transmittance, strong matching, strong coating,
firm resistance to high temperature and laser resistance**

Fast cutting speed, uniform texture, high mechanical strength, and longer precision processing life

Material	Diameter	Focusing
Single piece		
Quartz	φ20	F40 50 60/63 80 100 120 150 180 200
	φ24	F120
	φ25.4	F75 100 125 150 200
	φ24.5	F50 60/63 120 (high power)
	φ28	F60/63 100 125 150 200 250
	φ28	F75 100 120 (high power)
	φ30	F40 50 60/63 75 80 100 120 125 150 200
	φ34	F120 125 150 200
	φ36	F80 100 120 150 200 250
	φ38.1	F100 120 125 150 200 250 300
	φ41.5	F80 100 120 125 150
	φ42	F80 100 120 150 180 200
	φ50	F80 120 150 200
Material	Diameter	Focusing
Compound		
Quartz	φ25	F55
	φ28	F75 100 150
	φ30	F75 100 125 150 180 200
	φ37	F100 125 150 190 200
	φ38.1	F100 150 200
	φ50	F120

Product parameters

Diameter: 20-55mm

Thickness: 1-9mm

Wavelength: 1064nm

Transmittance: 99.5%

Depth of parallelism < 1

Material: Quartz

Surface quality: 40/20

Diameter tolerance: ±0.1mm

Thickness tolerance: ±0.1mm

Optical aperture < 80%

COLLIMATE FOCUS



Raytools BT210S Focus



Raytools BT240S Focus



Raytools BM114 Focus



Raytools BM110 Focus



Raytools BM109 Focus



Raytools BM115 Focus



Raytools BT240S Collimate



Raytools BM110 Collimate



Raytools BT210 Collimate

COLLIMATE FOCUS



Raytools BM114 Collimate



Raytools BM115 Collimate



Light Cutter Collimate



Light Cutter Focus

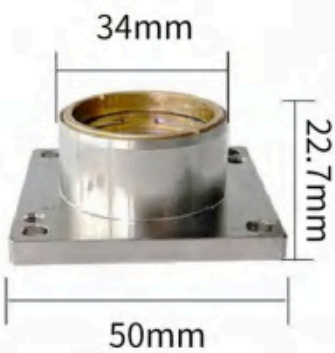

Precitec HP Collimate



Precitec HP Focus



Precitec Pro 1.0 Collimate



Precitec Pro1.0 Collimate



Precitec Pro1.0 Focus

COLLIMATE FOCUS >>>



Precitec 2.0 Collimate



Precitec 2.0 Focus

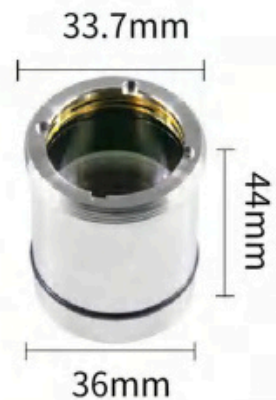

WSX NC30 Focus



WSX NC60/62 Focus



WSX NC60/62 Focus



WSX NC150 Focus

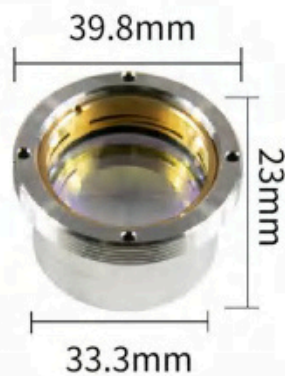

WSX NC30 Collimate



WSX NC60/62 Collimate

COLLIMATE FOCUS



High light transmittance
Fast cutting speed

Withstand high temperatures
Longer lifespan

Easy to install
And Easy to use

Full specifications
Wide application



SENSORS



Raytools BM109



Raytools BM109 BT230



Raytools BM110HM



Raytools BM110



Raytools BM111 BM110



Raytools BM112S



Raytools BM114



Raytools BM114S



Raytools BM115S

SENSORS



Raytools BM115(150)



Raytools BM115(200)



Raytools BT200(125)



Raytools BT200A(150)



Raytools BT210



Raytools BT210S



Raytools BT210S 3D



Raytools BT230 3D



Raytools BT230 Fibermini

SENSORS



Raytools BT240S

BMH109
BMH114S
BM111



Raytools BT240S 3D



LASER-MECH



WSX KC13/15



WSX NC30B



WSX NC30E



WSX NC60(F190)



WSX NC62(F200)



WS NC63(F200)

SENSORS



WSX NC63 3D



WSX SW18



WSX SW20



Precitec CM2 M30X0.75



Precitec CM2 M30X1

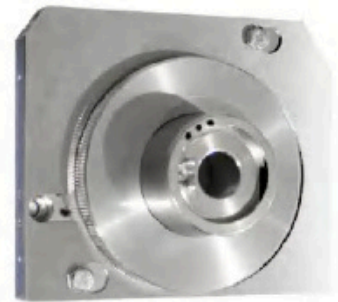

Precitec HP1.5HPSSL



LightCutter F100-200



LightCutter M ECO



Precitec Pro1.0 F150

SENSORS



Precitec Pro1.0 F150



Precitec Pro1.0 F200



Precitec Pro1.0 F200



Precitec Pro2.0 F150X



Precitec Pro2.0 F200X



Precitec SE M30*1 L53



HAN*S(customization)

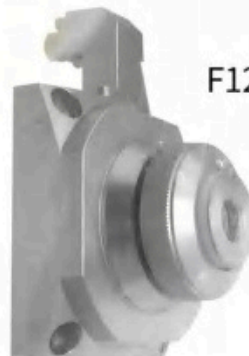

Ospri LC208/209



Ospri LC208/209

SENSORS



F125

Osprey LC40



F150

Osprey LC40



808
1208
1508

Osprey LC608



Osprey LC608/808



Osprey LC80



Osprey LC608/808

SEAL RING



Inner spring

36*29.6*2mm

HP Protective lens



53*46.5*2.6mm

HP Protective lens



Inner spring

36*29*3mm

HP Protective lens



Inner spring

60*54*2mm

HP Focus lens



Inner spring

41.5*34*3.35mm

Bodor 37-7



Inner spring

40.2*33*2.5mm

Bodor Pro37-7



Inner spring

27.8*21.4*2.6mm

Bodor



Inner spring

21*15*2.7mm

Chaoqiang18-2



Inner spring

40*30*3.95mm

DNE35-4

SEAL RING



Inner spring

54.5*47*3.5mm

DNE



Inner spring

60*50*4mm

DNE



Inner spring

22.4*16*3mm

Hanwei 20-4

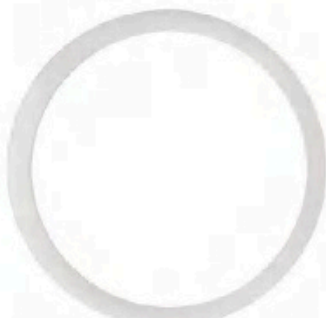

36.5*32*1.8mm

Raytools Protective lens



Inner spring

48*40*3.5mm

Raytools Laser head



Inner spring

29.2*21*3.5mm

Raytools Upper Protective lens

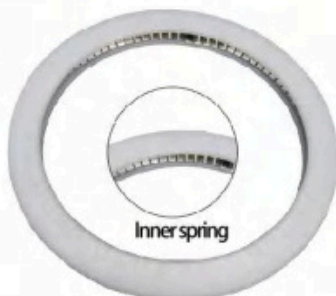

Inner spring

42.5*32.8*3.2mm

Raytools Lower Protective lens

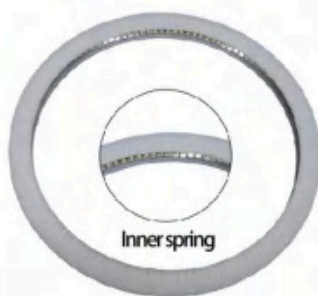

Inner spring

32.2*24*3.5mm

Raytools Lower Protective lens

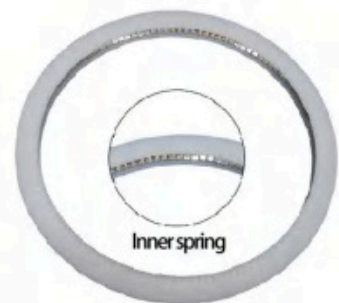

Inner spring

41.2*33.4*3.2mm

Raytools Lower Protective lens

SEAL RING

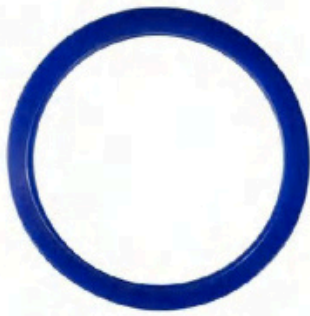

56*51.3*4mm

LEAD Blue



21*15*3.1mm

OsPRI 20-3



32*26*3mm

OsPRI 30-5

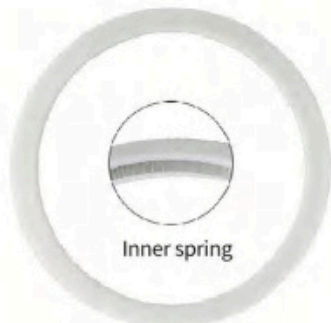

42.5*36*2.8mm

OsPRI 30-5 lower

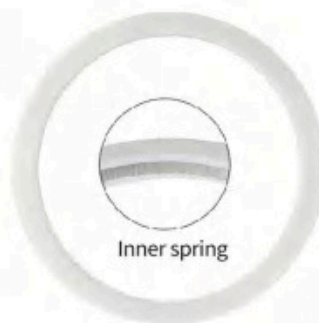

38*30*4mm

OsPRI 37-7



31.4*25.2*3mm

Precitec LC protective lens



44*33.4*2.6mm

Precitec Pro2.0 protective lens

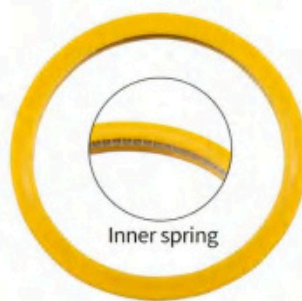

40*34.2*2.8mm

Precitec Pro protective lens

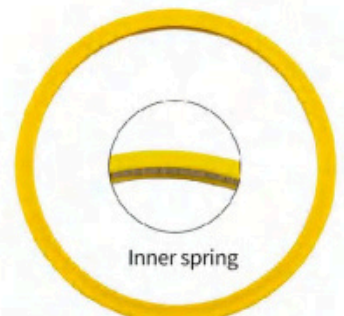

55.6*49*2.5mm

Precitec Focus lens

SEAL RING



Outer Spring

54.5*47*3mm

Precitec Focus lens



Inner Spring

31.5*23*2.72mm

Hans 30-5



Inner Spring

51*44*3.55mm

Hans 34-5

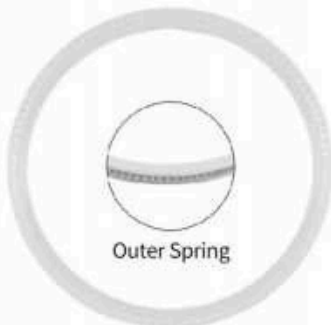

Outer Spring

44.3*37.6*3.2mm

Hans Outer spring



Inner Spring

25.4*19.8*3.2mm

WSX 25.4-4



Inner Spring

29.8*23.8*3mm

WSX 30-5



Inner Spring

37.5*31*2.7mm

WSX 37-7



Inner Spring

26.6*18*3.6mm

WSX 22.35-4

INDUCTION LINE



LASERMECH 280mm



Raytools 140mm



Raytools 150mm

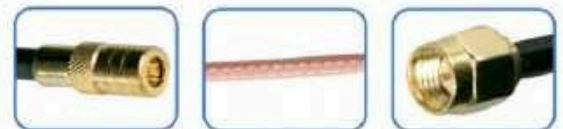

Raytools Long 180mm



DNE 255mm



HE Laser Short Type 150mm

INDUCTION LINE



HE Laser Long Type 265mm



Precitec/Unity 270mm



Hans 280mm

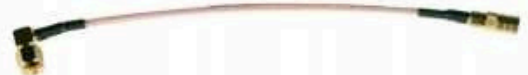

Bochu 180mm



Bochu/WSX 140mm



WSX 170mm

INDUCTION LINE



WSX 180mm



WSX 200mm



WSX 250mm



WSX 280mm



WSX Special edition 250mm

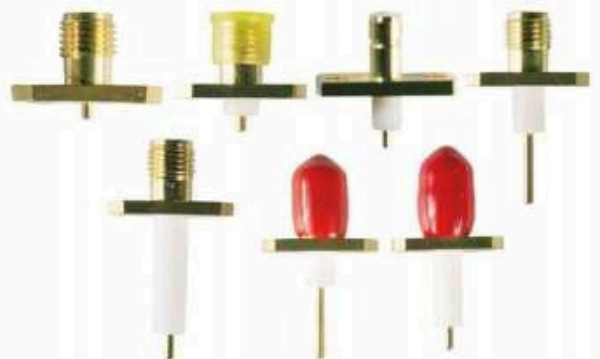

RF cable connector



High temperature resistant RF cable

Resist high temperatures | Signal stability | High sensitivity | Easy to install

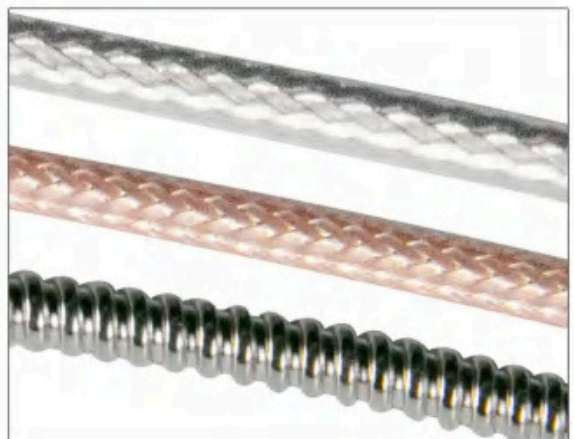
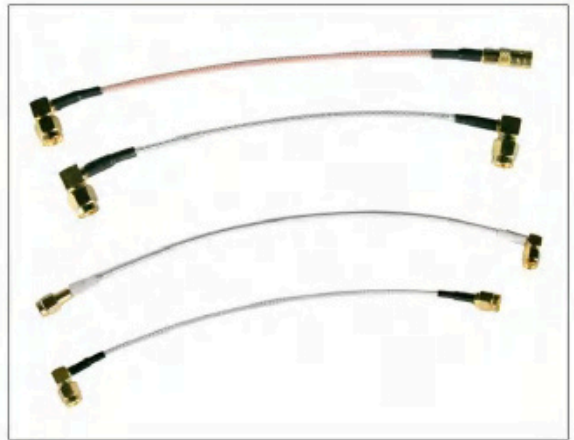

QBH



Raytools QBH Non water cooling



Raytools QBH Water cooling



Raytools QBH Water cooling new



Raytools QBH assembly



Precitec ZM COL QD



Precitec ZM COL Q+



Precitec ZM COLQBH III



Precitec ZM COLQBH K



WSXQBH

QBH



WSX QBH Water cooling



WSX Q+/C



Universal version QBH

LOCK NUT RING



Raytools BT240BM109



Raytools BT240S

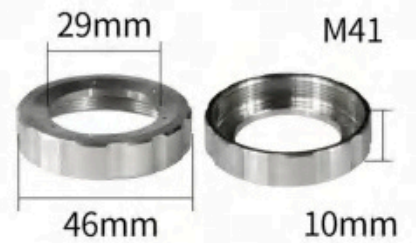

Raytools BM111/114



Raytools BT220BM115



Raytools 3D



Precitec 1.0



Precitec 2.0



WSX



WSXNew

LOCK NUT RING



WSX NC60



Osprilc608/1208



Osprilc208/209



Ospril3D

FIBER PROTECTIVE CAP



109901903



109901957



109901986



10901988



10902003



MAX Original 6KW



Customization



Feibo Original



Rofin

FIBER PROTECTIVE CAP



IPG domestic low power



IPG domestic high power



IPG Original



IPG Original



IPG Original low power



Raycus Original 10KW



Raycus Original low power



Raycus Original High Power



Raycus Original with steps

REMOVAL TOOL



Raytools BT210



Raytools BT230



Raytools BT240



Raytools BM109



Raytools BM111



Raytools BM114



Raytools BM115



WSX NC30 Collimator



WSX NC30 Focus

REMOVAL TOOL



WSX NC60 Focus



WSX NC60 Collimator



Precitec Removing lens



Precitec Focus



Precitec Collimator



Precitec removing tools -small



Precitec removing tools -medium



Precitec removing tools -large

PROTECTIVE LENS HOLDER



Precitec 2.0 Lower Holder



Precitec 2.0 Lower Holder

PW



Precitec 1.0 Upper Holder

15K



Precitec 1.0 Upper Holder



Precitec 1.0 Lower Holder



WSX KC13/15 Holder



WSX NC30 Upper Holder



WSX NC30 Lower Holder



WSX NC60 Upper Holder

**PROTECTIVE LENS
HOLDER**



WSX NC60 Lower Holder



Raytools BM109 Lower Holder

BM110
BM111



Raytools BM109 Upper Holder

BM111



Raytools BM110 Lower Holder



Raytools BM114 Upper Holder



Raytools BT240S Lower Holder



OsPRI LC40 Upper Holder



OsPRI LC40 Lower Holder

LC608
LC808
LC1208



OsPRI Holder

FILTER ELEMENT



Original IPG Filter



Domestic IPG Filter



Parker 010HE



Parker 010AC



Parker 010GP



Parker 015AA



Parker 015AO



Parker 015ACS



Parker 020AA

FILTER ELEMENT



Parker 020AO



Parker 020ACS



Parker 020HE



Parker 020GP



Parker 020AC



Parker 025AA



Parker 025AO



Parker 025ACS



Parker P33KA00ESE

FILTER ELEMENT



Parker AO020DBFX



Parker ACS020DBMX



PK-SPL19560 Automatic drain valve



PK-SP698024 Automatic drain valve



Tongfei MB400



S&A 20 inches



S&A 10 inches



S&A 5 inches



Atlas 1624187906

FILTER ELEMENT

